

E GATE®

USER MANUAL



CONTENTS

Important Safety Instructions -----	01
Packing List -----	03
Overview -----	04
Remote Control -----	05
Getting Started -----	06
Start Using -----	07
Electronic Keystone Correction -----	08-09
HDMI AV USB Connection -----	10
Wifi Settings -----	11
Screen Mirroring -----	12-14
Bluetooth Connection -----	15
Specifications -----	16
Trouble Shooting -----	17

Important Safety Instructions

Thank you for purchasing EGATE projector .

Please read this manual thoroughly before using and keep it for future reference

If physical injury , loss of data , or damage is caused by failure to follow instructions , the warranty does not apply

Set Up

- Do not install the projector in places without proper ventilation
- Do not install the projector in hot and humid places
- Do not install the projector in dusty or smokey places .
- Do not block the ventilation holes (intake or exhaust)
- Do not install the projector near the temperature and smoke detectors . It may cause a sensor failure .
- Do not install the projector in areas where warm and cool air will blow directly onto the projector ,otherwise it may cause projector failure due to moisture condensation or large temperature changes

Power Supply

- Power off the device before removing the power supply from the socket

- Use the power cord with caution to avoid unduly bending it
Damaged power cords may cause electricshock or fire
- Unplug this device if there are lightning storms or when unused for a long period of time .
- Never touch the power cable or the power connection with wet hands
- Unplug the power cord from the outlet after using the projector

Repairs

- No components in the projector can be repaired by customers .
- Please entrust qualified professional maintenance personnel for repair .

Caution

- Do not look at the lens or it may cause severe eye injury
- During and after use , the temperature near the outlet will rise .
Therefore touching it may cause burns .
- Do not place projector in too warm or too cold room , because the high temperature or low temperaturewill shorten lifespan of the device .

Packing List

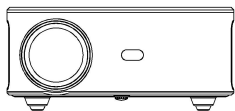

Projector



Remote (Batteries
Not included)



HDMI Cable



AV Cable



Power Cable



USER MANUAL

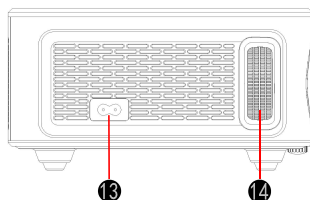
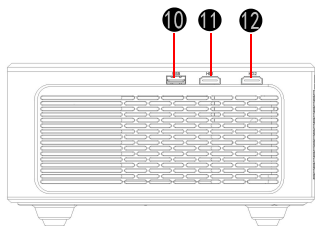
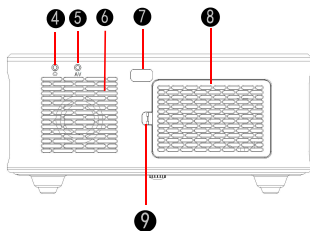
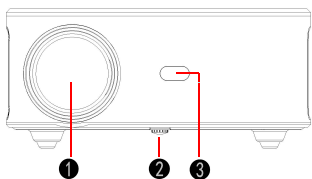

- 1.Focus Lens
- 2.Adjusting Knob
- 3.IR receiver
- 4.3.5mm port for audio output
- 5.AV port
- 6.Speaker
- 7.IR receiver
- 8.Removable dust cover

- 9.Switch Of Removable Dust Cover
- 10.USB port
- 11.HDMI 1 port
- 12.HDMI 2 port
- 13.Power Switch
- 14.focussing ring
- 15.Removable dust cover

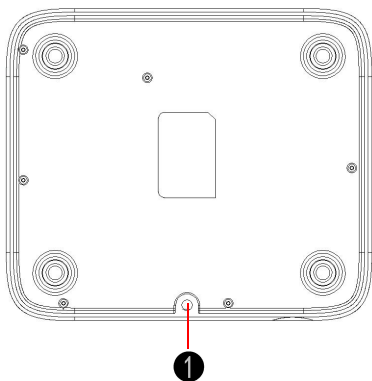

- 1.Adjusting Knob(Lifting nut)

Remote Control

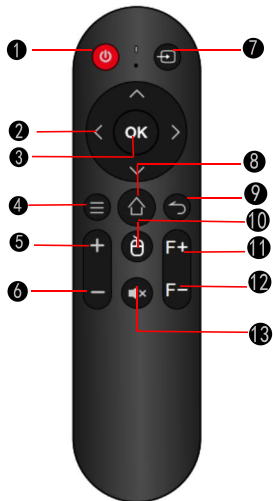

- 1.Power Switch
- 2.Direction Button
3. Confirm Button
- 4.Menu Button
- 5.Volume+
- 6.Volume-
- 7.Signal Source
- 8.Home Button
- 9.Back Button
- 10.Mouse
- 11.Camera Advance
- 12.Camera backward
- 13.Mute

Getting Started Projector Placement

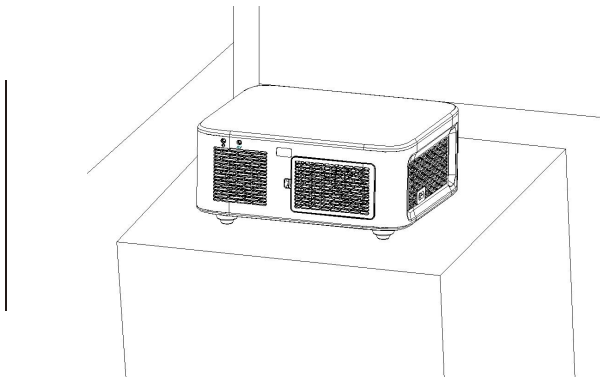

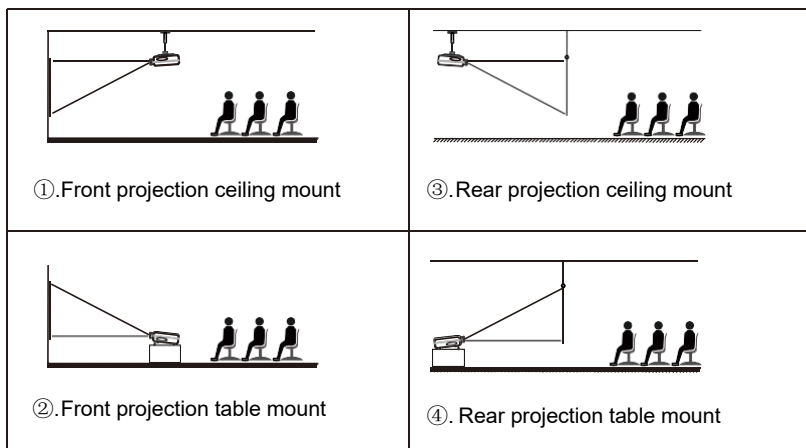

Note:

- (1) During the installation process, please do not operate with electricity to avoid electric shock hazard and projector circuit failure.
- (2) Please keep a gap of at least 30 cm from the wall. Do not cover or block the projector's vents with any objects. Make sure that the projector has enough ventilation to ensure the projector's performance and reliability.
- (3) If you have a projector screen and need to be mounted on a ceiling, the projector cannot be higher than the upper edge of the screen, otherwise it will affect the image effect.

Ceiling installation

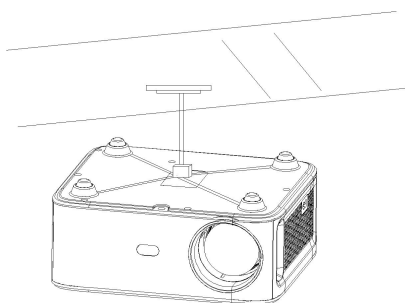

Screw holes

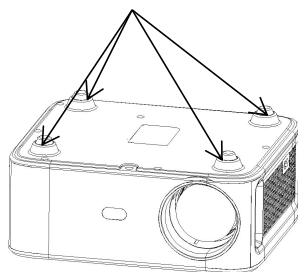

1. Please purchase a universal projector ceiling mount;
2. Remove the four rubber pads on the button of the projector, you will see the screw holes and use the M4*10mm screws for installing the ceiling, and then install it.

Start Using

Power On

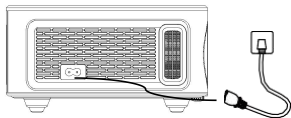

1 Plug the power cord into an outlet.

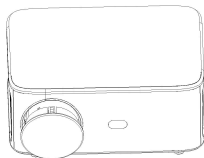

2 Take off the lens cover.

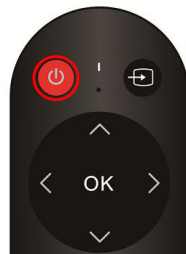

3 Press the power button to turn on the projector.

Projector Distance & Size

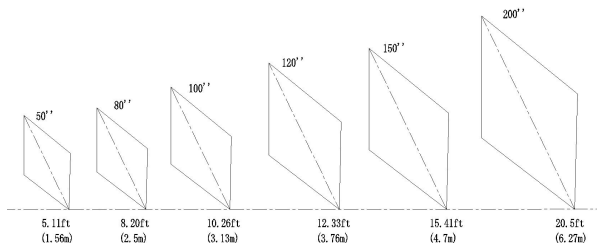
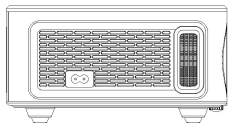

Though the projection may go up to as high as 300 inches, the recommended projection screen is around 120 inches. Ambient darkness will improve the clarity of the projected images.

Aspect Ratio(16:9)	
Distance	Screen Size(inch)
5.11ft(1.56m)	50
8.20ft(2.50m)	80
10.26ft (3.13m)	100
12.33ft (3.76m)	120
15.41ft (4.70m)	150
20.5ft (6.27m)	200

Adjusting the projected image

After adjusting the size and distance of the projector, please rotate the focus ring Up and Down to change the front and rear positions of the lens until a clear image is obtained.



FOCUS



Electronic keystone correction

Vertical keystone correction

Step 1: Press the "Setting" button on the remote or on projector to enter the setting interface.

Step 2: Select the projected image settings, press "OK" to enter, select [Auto Trapezoid] in the [Projection] column, and turn off [Auto Trapezoid] to enter the manual adjustment mode

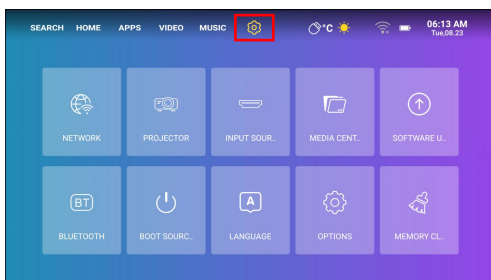

Step 3: Select [side Trapezoid], press OK to enter the keystone adjustment page, use the remote control or the direction buttons of the projector to adjust the vertical parameters in the manual keystone option until you get a vertical

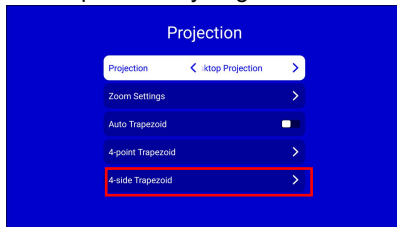
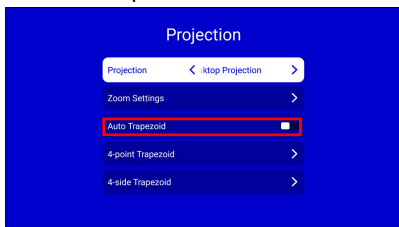

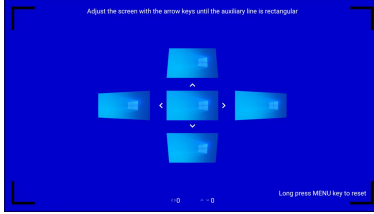

Four-point keystone correction (horizontal and vertical keystone correction)

When the projected image is not rectangular, it can be adjusted by four-point keystone correction

Step 1: Use the remote control or projector buttons to enter the setting interface.

Step 2: Select the projected image settings, press OK to enter, select [Auto Trapezoid] in the [Projection] column, and turn off [Auto Trapezoid] to enter the manual adjustment mode

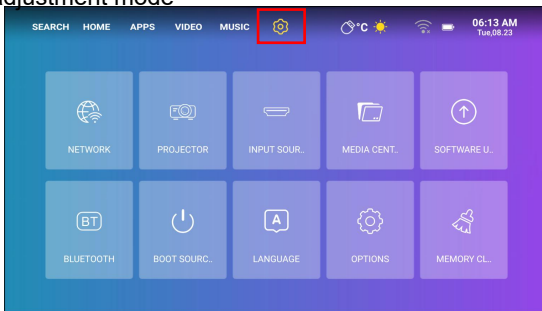

Step 3: Select [Point Trapezoid] and press OK to enter the page, use the direction buttons of the remote control or the projector to adjust the projected image according to the graphics. After adjusting the current point, press the OK button to go to the next corner point.

Step 4: After adjusting the four points, press the return key to save the current state

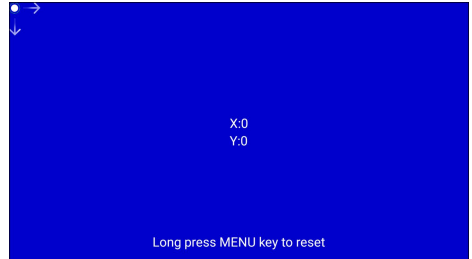
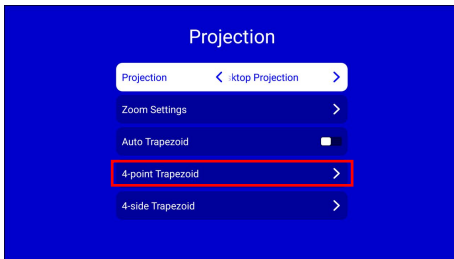

Input Source

A.HDMI mode

Step 1: Connect the projector and equipment with HDMI cable.

Step 2: Press and hold the <Source button> on the projector or on the remote control to enter the input source interface and select HDMI.

Step 3: Select the HDMI cable to connect to the corresponding interface HDMI1 or HDMI2, press the OK key to enter the interface, and press the return key to exit and return to the main interface of the projector.

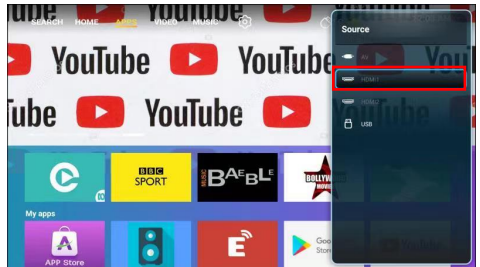
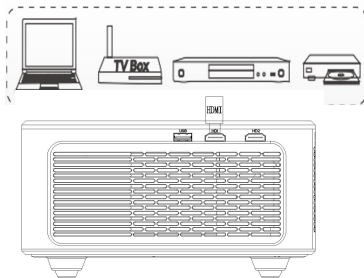

B.AV mode

Step 1: Connect the projector and the equipment with the AV cable.

Step 2: Press and hold the source button of the projector or remote control to enter the input source interface.

Step 3: Select AV, press OK to enter, press Return to exit and return to the main interface of the projector.

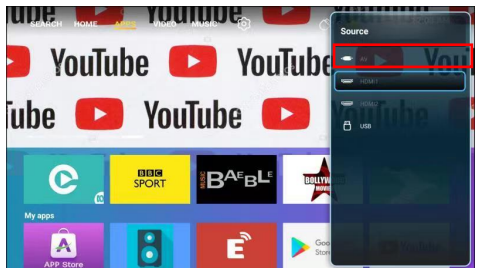
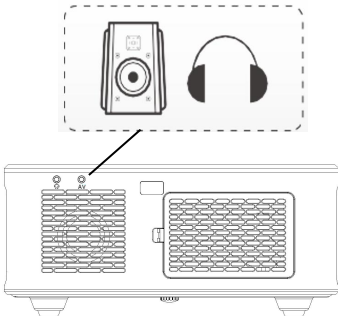

C.USB mode

Step 1: Connect the projector to the U disk, the U disk on the main interface of the projection screen will display the highlighted state.

Step 2: Select the corresponding Movie,Music,Picture and Office Suite modules of the file type, and press OK to enter the file.

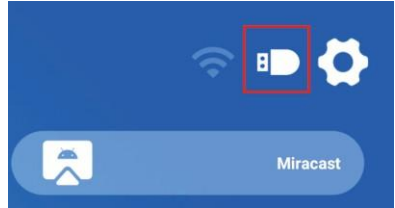
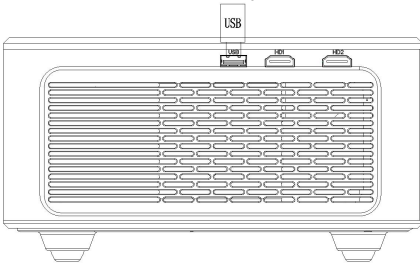

WiFi settings

Step 1: Use the remote control or the projector button to enter the setting interface . Step 2: Find the <NETWORK> in the setting interface, press the OK button to enter the WIFI setting; press the OK button to turn on the WIFI, and the WIFI name list will appear. Step 3: Select the name of the WiFi to be connected, press the OK key to display the virtual keyboard, use the remote control to enter the password, place the control cursor on the keyboard [Finish], and press the OK key to complete the password input

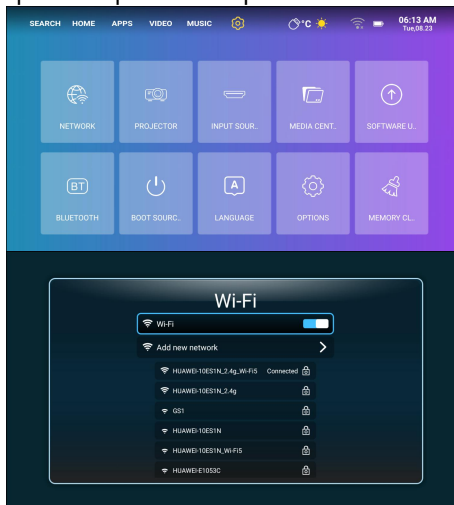

Screen Mirroring

For iOS Devices (streaming using WiFi)

Note: It only enables screen mirroring over WiFi, not iOS device data.

Step 1: Connect the projector to WIFI according to the projector WIFI setting steps, and turn on WIFI on your iPhone, please make sure your iPhone and projector are connected under the same WIFI.

Step 2: On the projector's main menu, use the remote control to select the settings icon and select the WIFI option

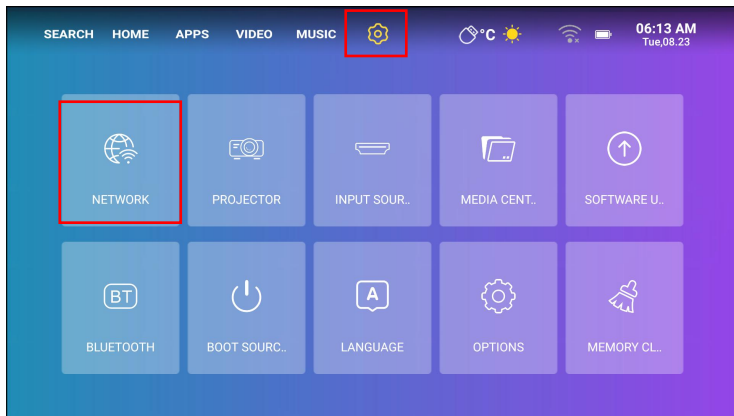

Step 3: Select the WiFi to be connected, press the OK key to display the virtual keyboard, use the remote control to enter the password, place the control cursor on the keyboard [Finish], and press the OK key to complete the password input (connecting the mouse to enter the WiFi password is more convenient)

Step 4: After entering the password, use the directional buttons on the remote control to move the cursor to [Connect], then press OK to connect.

Step 5: On the IOS device page, slide up to enter the options interface, click the Screen Mirroring icon, select the projector name Eshare-xxxx, and click Connect



For Android Devices(Streaming with WiFi)

Step 1: Connect the projector to WIFI according to the projector WIFI setting steps, open the main menu of the projector, Select Eshare icon, and press the OK button to enter.

Step 2: Follow the interface prompts to scan the Eshare QR code with your mobile device, download the (Eshare) APP to your mobile device, open the (Eshare) after the download is complete, and use the mobile device mirroring function with one-click screen sharing

Step 3: After successful connection, the screen content of the Android device will be projected onto the projection surface

Note: The mobile device and the projector should be connected the same Wifi

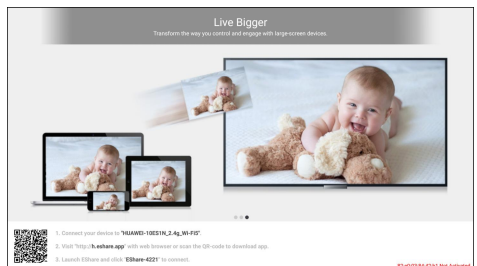
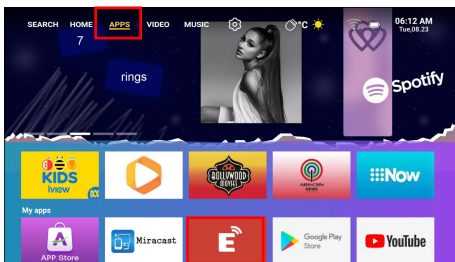

For MacBook device

Step 1: Connect the projector to the WIFI according to the projector WIFI setting steps, and open the computer network settings, Please make sure the Macbook and the projector are connected under the same WIFI.

Step 2: Open the settings, find Airplay option, click and search for the projector.

Step 3: Select the current projector device: EShare-xxxx, click and connect.

Step 4: When the projector and the device content are consistent, screen mirroring is successful.



For Windows PC (Wireless Miracast support Window 7.8.10 system)

Step 1: Connect the projector to the WIFI according to the projector WIFI setting steps, the WIFI needs to be the same as the computer WIFI

Step 2: Enter the URL <http://h.eshare.app> on the computer, and select the (Eshare for Windows) option to download

Step 3: After the download is complete, open the EShare APP, select one-click screen sharing, and the screen mirroring is successful.

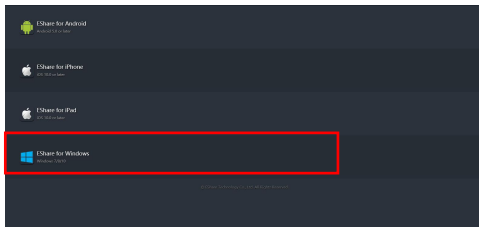

Bluetooth mode

NOTE: The projector can be connected to external speakers via Bluetooth. It can also connect to a smartphone or tablet for music streaming via Bluetooth. In Bluetooth mode, the projector can be used as a Bluetooth speaker.

How to connect the projector to external speakers:

Step 1: Use the remote control or the projector button to enter the setting interface of the projector

Step 2: Find the Bluetooth settings on the setting interface, press OK to enter the Bluetooth settings, select Add accessory, a list of Bluetooth devices will be displayed

Step 3: Select the Bluetooth speaker from the device list to connect, then press OK to pair.

Step 4: After successful connection, it will show connected on the Bluetooth device.

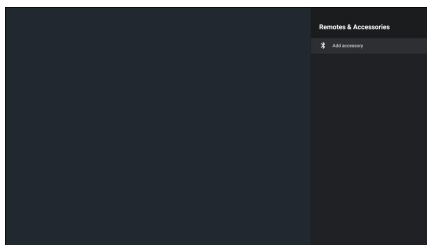
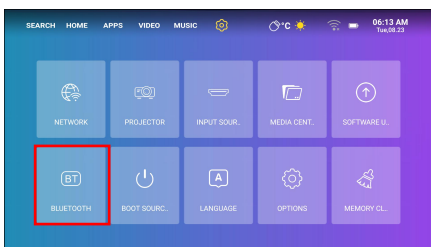

How to connect the projector to the phone via bluetooth:

Step 1: Use the remote control or projector button to move the cursor to APPS on the main interface of the projector

Step 2: Use the remote control or projector button to move the cursor down to the Bluetooth icon under My apps, and press OK to enter the Bluetooth connection interface

Step 3: Turn on the Bluetooth of the mobile phone, find the Bluetooth name of the projector (Projector), and click the pairing connection

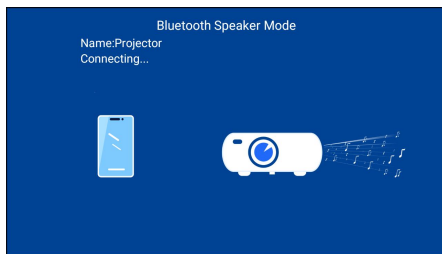
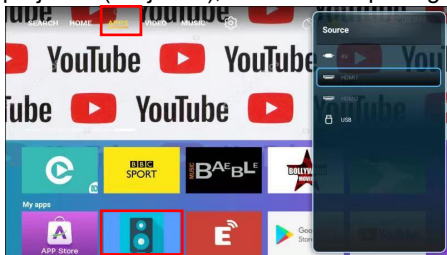

How to download the APPS

Step 1: Find the APPS icon on the projector's main menu page with the remote control direction keys, control the remote control to press down to move the cursor to the APP Store icon, and press the OK key to enter

Step 2: Click the search icon to find the APP you need to download

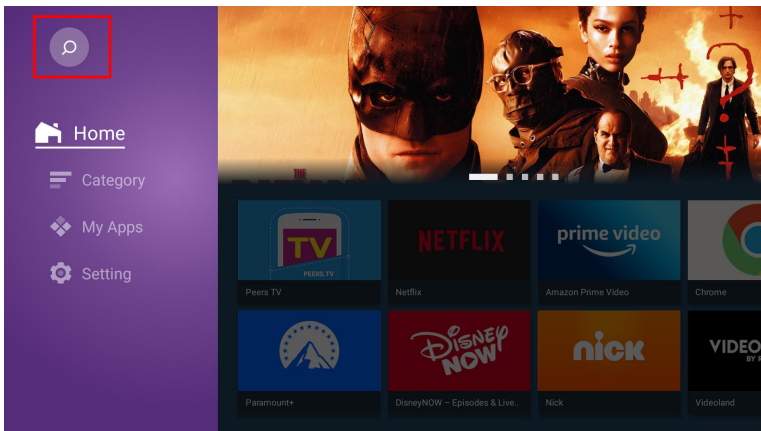
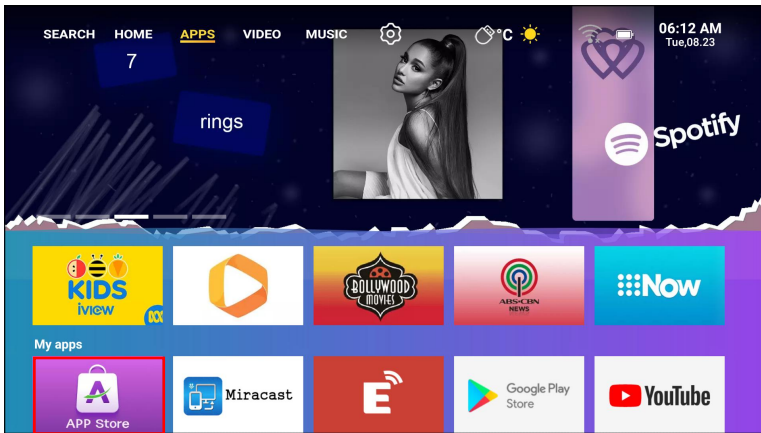

Specifications

Display Technology	LCD		light source	LED
Aspect Ratio	16:9/4:3/Auto		focus	Auto
Keystone	Auto \pm 50°		projection mode	Front / Rear / Ceiling
Speaker	5W*2 DOLBY		power supply	AC100-240V , 50 / 60HZ
Unit Dimension	256.9*219.6*101.5		unit net weight	2.6kg/50/60Hz
Photo FormatSupported	JPG/JPEG/PNG/BMP		audio formatsupported	MP3 / AAC / FLAC / OGG / WAV/ WMA / MID / DTS / M4A
Video FormatSupported	3GP / AVI / FLV / MP4 / MPG /VOB / TS / M2TS / RMVB / MKV		ports	HDMI *2 / USB 2.0 *1 / Audio in*1 / AV out* 1

Trouble Shooting

Q1.Blurry Image

- Make sure the projection distance is fartherthan the minimum projection distance of 1.3 m.
- Adjust focus ring.

Q2.The projector image shows no signal

- Please make sure all cables are connected to the projector properly and stably.
- Check whether the projector input source modehas been selected as the corresponding format.
- For example:the device and the projector are connected with an HDMI cable, the HDMI input channel must be selected for projection,and no signalwill be displayed if other channels are selected.

Q3.Remote Unresponsive

- Make sure remote points at IR receiver directly.
- Do not cover IR receiver.
- *Try a new pair of AAA batteries.

Q4.The projector will stop automatically every after time it is used for a period of time

- Check if the projector's air inlet and outlet are blocked by other objects.
- Please pay attention to whether the local mains voltage is too low or too high or fluctuates too much.



E GATE[®]

Mail : support@egin.in call : 0 706517 9993 / 4 / 5

Ship To : Service Centre ,

504, SG Alpha Tower II, Sec-9, Vasundhara, Ghaziabad , UP 201012.

E. & O.E. : Any matter or legal dispute will be entertained in the jurisdiction of Ghaziabad Court only.

